





Obsah

Table of contents

OBSAH

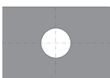
Table of contents

7.5	Izolační desky 330 N/mm² <i>Insulating plates 330 N/mm²</i>		MS0101
7.12	Izolační desky 330 N/mm² <i>Insulating plates 330 N/mm²</i>		MS01011
7.19	Izolační desky 600 N/mm² <i>Insulating plates 600 N/mm²</i>		MS0102
7.25	Izolační desky 600 N/mm² <i>Insulating plates 600 N/mm²</i>		MS01021
7.31	Izolační desky – kruhové <i>Insulating plates – round</i>		MS0103
7.32	Izolační desky – kruhové <i>Insulating plates – round</i>		MS01031
7.33	Speciální izolační desky <i>Special insulating plates</i>		

Izolační desky

Insulating plates

MS0101

330 N/mm²

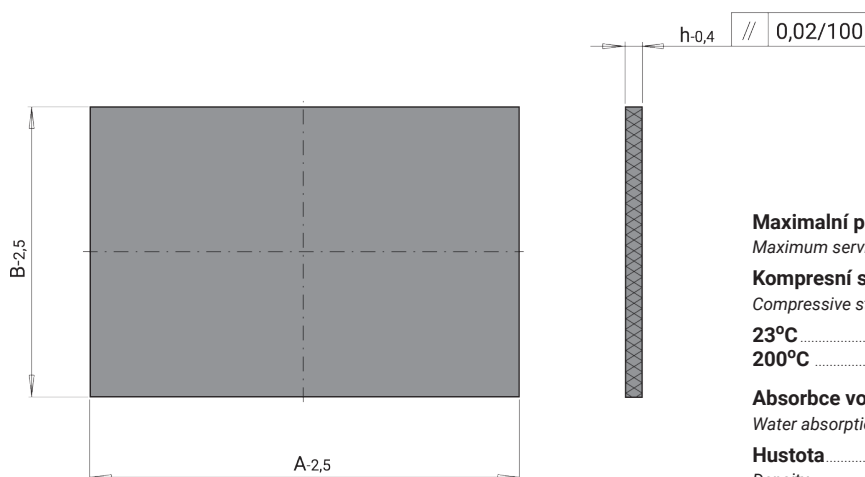

- Maximální provozní teplota:** 210°C
Maximum service temperature
- Kompresní síla:**
Compressive strength:
- 23°C** 330 N/mm²
- 200°C** 120 N/mm²
- Absorbce vody:** 0,1 %
Water absorption
- Hustota** 1,8 g/cm³
Density
- Teplotní vodivost:** 0,18 W/m K
Thermal conductivity

B	A	h	Katalogové označení
95	95	3	MS0101-095 095/3
100	130		MS0101-100 130/3
156	156		MS0101-156 156/3
	196		MS0101-156 196/3
	246		MS0101-156 246/3
	296		MS0101-156 296/3
	396		MS0101-156 396/3
190	246		MS0101-190 246/3
	296		MS0101-190 296/3
196	196		MS0101-196 196/3
	246		MS0101-196 246/3
	296		MS0101-196 296/3
	346		MS0101-196 346/3
206	156		MS0101-206 156/3
	196		MS0101-206 196/3
218	246		MS0101-218 246/3
	296		MS0101-218 296/3
246	246		MS0101-246 246/3
	296		MS0101-246 296/3
254	246		MS0101-254 246/3
276			MS0101-276 246/3
296	296		MS0101-276 296/3
			MS0101-296 296/3

Izolační desky

Insulating plates

MS0101

B	A	h	Katalogové označení
95	95	5	MS0101-095 095/5
100	130		MS0101-100 130/5
156	156		MS0101-156 156/5
	196		MS0101-156 196/5
	246		MS0101-156 246/5
	296		MS0101-156 296/5
	396		MS0101-156 396/5
190	246		MS0101-190 246/5
	296		MS0101-190 296/5
196	196		MS0101-196 196/5
	246		MS0101-196 246/5
	296		MS0101-196 296/5
	346		MS0101-196 346/5
	396		MS0101-196 396/5
	446		MS0101-196 446/5
206	156		MS0101-206 156/5
	196		MS0101-206 196/5
218	246		MS0101-218 246/5
	296		MS0101-206 296/5
	396		MS0101-206 396/5
246	246		MS0101-246 246/5
	296		MS0101-246 296/5
	346		MS0101-246 346/5
	396		MS0101-246 396/5
	446		MS0101-246 446/5
	496		MS0101-246 496/5
254	246		MS0101-254 246/5
276			MS0101-276 246/5
296	296		MS0101-296 296/5
	346		MS0101-296 346/5
	396	MS0101-296 396/5	
	446	MS0101-296 446/5	
	496	MS0101-296 496/5	
	546	MS0101-296 546/5	
	596	MS0101-296 596/5	
	346	346	MS0101-346 346/5
396		MS0101-346 396/5	
446		MS0101-346 446/5	
496		MS0101-346 496/5	
546		MS0101-346 546/5	

Izolační desky

Insulating plates

MS0101

B	A	h	Katalogové označení
396	396	5	MS0101-396 396/5
	446		MS0101-396 446/5
	496		MS0101-396 496/5
126	156	6	MS0101 -126 156/6
	246		MS0101 -126 246/6
156	156		MS0101 -156 156/6
	196		MS0101 -156 196/6
	206		MS0101 -156 206/6
	246		MS0101 -156 246/6
	296		MS0101 -156 296/6
	346		MS0101 -156 346/6
	396		MS0101 -156 396/6
446	MS0101 -156 446/6		
196	196		MS0101 -196 196/6
	206		MS0101 -196 206/6
	246		MS0101 -196 246/6
	296		MS0101 -196 296/6
	346	MS0101 -196 346/6	
	396	MS0101 -196 396/6	
	446	MS0101 -196 446/6	
216	246	MS0101 -216 246/6	
	296	MS0101 -216 296/6	
	396	MS0101 -216 396/6	
246	246	MS0101 -246 246/6	
	266	MS0101 -246 266/6	
	296	MS0101 -246 296/6	
	346	MS0101 -246 346/6	
	396	MS0101 -246 396/6	
	446	MS0101 -246 446/6	
	496	MS0101 -246 496/6	
	546	MS0101 -246 546/6	
596	MS0101 -246 596/6		
266	296	MS0101 -266 296/6	
196	296	7	MS0101 -196 296/7
	346		MS0101 -196 346/7
	396		MS0101 -196 396/7
	446		MS0101 -196 446/7
218	396		MS0101 -218 396/7

Izolační desky
Insulating plates

MS0101

B	A	h	Katalogové označení	
246	246	7	MS0101 -246 246/7	
	296		MS0101 -246 296/7	
	346		MS0101 -246 346/7	
	396		MS0101 -246 396/7	
	446		MS0101 -246 446/7	
254	246		MS0101 -254 246/7	
276	296		MS0101 -276 296/7	
296			346	MS0101 -296 296/7
			396	MS0101 -296 346/7
			446	MS0101 -296 396/7
			496	MS0101 -296 446/7
346	346		MS0101 -346 346/7	
	396		MS0101 -346 396/7	
	446		MS0101 -346 446/7	
	496		MS0101 -346 496/7	
	546		MS0101 -346 546/7	
396	396		MS0101 -396 396/7	
	446		MS0101 -396 446/7	
	496		MS0101 -396 496/7	
	546		MS0101 -396 546/7	
496	546		MS0101 -496 546/7	
296	296		8	MS0101 -296 296/8
	346			MS0101 -296 346/8
	396			MS0101 -296 396/8
	446			MS0101 -296 446/8
	496	MS0101 -296 496/8		
	546	MS0101 -296 546/8		
	596	MS0101-296 596/8		
	646	MS0101-296 646/8		
	696	MS0101-296 696/8		
346	346	MS0101-346 346/8		
	396	MS0101-346 396/8		
	446	MS0101-346 446/8		
	496	MS0101-346 496/8		
	546	MS0101-346 546/8		
	596	MS0101-346 596/8		
	646	MS0101-346 646/8		
	696	MS0101-346 696/8		
	796	MS0101-346 796/8		
396	396	MS0101-396 396/8		
	446	MS0101-396 446/8		

Izolační desky

Insulating plates

MS0101

B	A	h	Katalogové označení
396	496	8	MS0101-396 496/8
	546		MS0101-396 546/8
	596		MS0101-396 596/8
	646		MS0101-396 646/8
	696		MS0101-396 696/8
	796		MS0101-396 796/8
446	446		MS0101-446 446/8
	496		MS0101-446 496/8
	546		MS0101-446 546/8
	596		MS0101-446 596/8
	646		MS0101-446 646/8
	696		MS0101-446 696/8
496	796		MS0101-446 796/8
	496		MS0101-496 496/8
	546		MS0101-496 546/8
	596		MS0101-496 596/8
	646		MS0101-496 646/8
	696		MS0101-496 696/8
546	796		MS0101-496 796/8
	546		MS0101-546 546/8
	596		MS0101-546 596/8
	646		MS0101-546 646/8
	696		MS0101-546 696/8
	796		MS0101-546 796/8
596	596	MS0101-596 596/8	
	646	MS0101-596 646/8	
	696	MS0101-596 696/8	
	796	MS0101-596 796/8	
	896	MS0101-596 896/8	
596	996	MS0101-596 996/8	
646	646	MS0101-646 646/8	
	696	MS0101-646 696/8	
	796	MS0101-646 796/8	
	896	MS0101-646 896/8	
	996	MS0101-646 996/8	
696	696	MS0101-696 696/8	
	746	MS0101-696 746/8	
	796	MS0101-696 796/8	
	896	MS0101-696 896/8	
	996	MS0101-696 996/8	

Izolační desky
Insulating plates

MS0101

B	A	h	Katalogové označení
746	796	8	MS0101-746 796/8
	896		MS0101-746 896/8
	996		MS0101-746 996/8
796	796		MS0101-796 796/8
	846		MS0101-796 846/8
	896		MS0101-796 896/8
	996		MS0101-796 996/8
846	896		MS0101-846 896/8
	996		MS0101-846 996/8
246	496	8,5	MS0101-246 496/8,5
296	296		MS0101-296 296/8,5
	346		MS0101-296 346/8,5
	396		MS0101-296 396/8,5
	446		MS0101-296 446/8,5
	496		MS0101-296 496/8,5
	546		MS0101-296 546/8,5
	596		MS0101-296 596/8,5
	696		MS0101-296 696/8,5
346	346		MS0101-346 346/8,5
	396		MS0101-346 396/8,5
	446		MS0101-346 446/8,5
	496		MS0101-346 496/8,5
	546		MS0101-346 546/8,5
	596		MS0101-346 596/8,5
	696		MS0101-346 696/8,5
	796		MS0101-346 796/8,5
396	396		MS0101-396 396/8,5
	446		MS0101-396 446/8,5
	496		MS0101-396 496/8,5
	546		MS0101-396 546/8,5
	596	MS0101-396 596/8,5	
	696	MS0101-396 696/8,5	
	796	MS0101-396 796/8,5	
	896	MS0101-396 896/8,5	
446	446	MS0101-446 446/8,5	
	496	MS0101-446 496/8,5	
	546	MS0101-446 546/8,5	
	596	MS0101-446 596/8,5	
	696	MS0101-446 696/8,5	
	796	MS0101-446 796/8,5	
	896	MS0101-446 896/8,5	

Izolační desky

Insulating plates

MS0101

B	A	h	Katalogové označení
496	496	8,5	MS0101-496 496/8,5
	546		MS0101-496 546/8,5
	596		MS0101-496 596/8,5
	696		MS0101-496 696/8,5
	796		MS0101-496 796/8,5
	896		MS0101-496 896/8,5
	996		MS0101-496 996/8,5
546	546		MS0101-546 546/8,5
	596		MS0101-546 596/8,5
	646		MS0101-546 646/8,5
	696		MS0101-546 696/8,5
	796		MS0101-546 796/8,5
	896		MS0101-546 896/8,5
	996		MS0101-546 996/8,5
596	596		MS0101-596 596/8,5
	696		MS0101-596 696/8,5
	796		MS0101-596 796/8,5
	896		MS0101-596 896/8,5
	996		MS0101-596 996/8,5
646	596		MS0101-646 596/8,5
	696		MS0101-646 696/8,5
	796		MS0101-646 796/8,5
	896		MS0101-646 896/8,5
	996		MS0101-646 996/8,5
696	696		MS0101-696 696/8,5
	796		MS0101-696 796/8,5
	896		MS0101-696 896/8,5
	996		MS0101-696 996/8,5
796	796	MS0101-796 796/8,5	
	896	MS0101-796 896/8,5	
	996	MS0101-796 996/8,5	
896	896	MS0101-896 896/8,5	
	996	MS0101-896 996/8,5	

Izolační desky

Insulating plates

MS01011

330 N/mm²

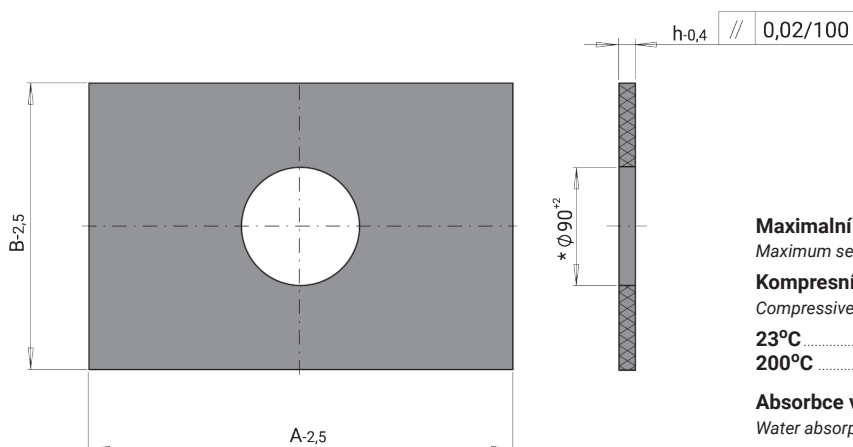

* Průměr otvoru 22 mm pro desky 95x95 mm a 100x130 mm
holes diameters 22 mm for plates with sizes 95x95mm and 100x130 mm

Maximální provozní teplota:..... 210°C
Maximum service temperature

Kompresní síla:
Compressive strength:

23°C 330 N/mm²
200°C 120 N/mm²

Absorbce vody:..... 0,1 %
Water absorption

Hustota 1,8 g/cm³
Density

Teplotní vodivost: 0,18 W/m K
Thermal conductivity

B	A	h	Katalogové označení
95*	95*	3	MS01011-095 095/3
100*	130*		MS01011-100 130/3
156	156		MS01011-156 156/3
	196		MS01011-156 196/3
	246		MS01011-156 246/3
	296		MS01011-156 296/3
	396		MS01011-156 396/3
190	246		MS01011-190 246/3
	296		MS01011-190 296/3
196	196		MS01011-196 196/3
	246		MS01011-196 246/3
	296		MS01011-196 296/3
	346		MS01011-196 346/3
206	156		MS01011-206 156/3
	196		MS01011-206 196/3
218	246		MS01011-218 246/3
	296		MS01011-218 296/3
246	246		MS01011-246 246/3
	296		MS01011-246 296/3
254	246		MS01011-254 246/3
276	246		MS01011-276 246/3
	296		MS01011-276 296/3
296	296		MS01011-296 296/3

Izolační desky

Insulating plates

MS01011

B	A	h	Katalogové označení
95*	95*	5	MS01011-095 095/5
100*	130*		MS01011-100 130/5
156	156		MS01011-156 156/5
	196		MS01011-156 196/5
	246		MS01011-156 246/5
	296		MS01011-156 296/5
	396		MS01011-156 396/5
190	246		MS01011-190 246/5
	296		MS01011-190 296/5
196	196		MS01011-196 196/5
	246		MS01011-196 246/5
	296		MS01011-196 296/5
	346		MS01011-196 346/5
	396		MS01011-196 396/5
	446		MS01011-196 446/5
206	156		MS01011-206 156/5
	196		MS01011-206 196/5
218	246		MS01011-218 246/5
	296		MS01011-218 296/5
	396		MS01011-218 396/5
246	246		MS01011-246 246/5
	296		MS01011-246 296/5
	346		MS01011-246 346/5
	396		MS01011-246 396/5
	446		MS01011-246 446/5
	496		MS01011-246 496/5
254	246		MS01011-254 246/5
276			MS01011-276 246/5
296	296		MS01011-296 296/5
	346		MS01011-296 346/5
	396		MS01011-296 396/5
	446		MS01011-296 446/5
	496	MS01011-296 496/5	
	546	MS01011-296 546/5	
	596	MS01011-296 596/5	
	346	346	MS01011-346 346/5
396		MS01011-346 396/5	
446		MS01011-346 446/5	
496		MS01011-346 496/5	
546		MS01011-346 546/5	

Izolační desky
Insulating plates

MS01011

B	A	h	Katalogové označení
396	396	5	MS01011-396 396/5
	446		MS01011-396 446/5
	496		MS01011-396 496/5
126	156	6	MS01011-126 156/6
	246		MS01011-126 246/6
156	156		MS01011-156 156/6
	196		MS01011-156 196/6
	206		MS01011-156 206/6
	246		MS01011-156 246/6
	296		MS01011-156 296/6
	346		MS01011-156 346/6
	396		MS01011-156 396/6
	446		MS01011-156 446/6
196	196		MS01011-196 196/6
	206		MS01011-196 206/6
	246		MS01011-196 246/6
	296		MS01011-196 296/6
	346		MS01011-196 346/6
	396		MS01011-196 396/6
	446		MS01011-196 446/6
	496		MS01011-196 496/6
216	246		MS01011-216 246/6
	296		MS01011-216 296/6
	396	MS01011-216 396/6	
246	246	MS01011-246 246/6	
	266	MS01011-246 266/6	
	296	MS01011-246 296/6	
	346	MS01011-246 346/6	
	396	MS01011-246 396/6	
	446	MS01011-246 446/6	
	496	MS01011-246 496/6	
	546	MS01011-246 546/6	
	596	MS01011-246 596/6	
266	296	MS01011-266 296/6	
196	296	7	MS01011-196 296/7
	346		MS01011-196 346/7
	396		MS01011-196 396/7
	446		MS01011-196 446/7
218	396		MS01011-218 396/7

Izolační desky
Insulating plates

MS01011

B	A	h	Katalogové označení	
246	246	7	MS01011-246 246/7	
	296		MS01011-246 296/7	
	346		MS01011-246 346/7	
	396		MS01011-246 396/7	
	446		MS01011-246 446/7	
254	246		MS01011-254 246/7	
276	296		MS01011-276 296/7	
296			346	MS01011-296 296/7
			396	MS01011-296 346/7
			446	MS01011-296 396/7
			446	MS01011-296 446/7
346	346		MS01011-346 346/7	
	396		MS01011-346 396/7	
	446		MS01011-346 446/7	
	496		MS01011-346 496/7	
	546		MS01011-346 546/7	
396	396		MS01011-396 396/7	
	446		MS01011-396 446/7	
	496		MS01011-396 496/7	
	546		MS01011-396 546/7	
496	546	MS01011-496 546/7		
296	296	8	MS01011-296 296/8	
	346		MS01011-296 346/8	
	396		MS01011-296 396/8	
	446		MS01011-296 446/8	
	496		MS01011-296 496/8	
	546		MS01011-296 546/8	
	596		MS01011-296 596/8	
	646		MS01011-296 646/8	
	696		MS01011-296 696/8	
346	346		MS01011-346 346/8	
	396		MS01011-346 396/8	
	446		MS01011-346 446/8	
	496		MS01011-346 496/8	
	546		MS01011-346 546/8	
	596		MS01011-346 596/8	
	646		MS01011-346 646/8	
	696		MS01011-346 696/8	
	796		MS01011-346 796/8	

Izolační desky
Insulating plates

MS01011

B	A	h	Katalogové označení
396	396	8	MS01011-396 396/8
	446		MS01011-396 446/8
	496		MS01011-396 496/8
	546		MS01011-396 546/8
	596		MS01011-396 596/8
	646		MS01011-396 646/8
	696		MS01011-396 696/8
	796		MS01011-396 796/8
446	446		MS01011-446 446/8
	496		MS01011-446 496/8
	546		MS01011-446 546/8
	596		MS01011-446 596/8
	646		MS01011-446 646/8
	696		MS01011-446 696/8
	796		MS01011-446 796/8
496	496		MS01011-496 496/8
	546		MS01011-496 546/8
	596		MS01011-496 596/8
	646		MS01011-496 646/8
	696		MS01011-496 696/8
	796		MS01011-496 796/8
546	546		MS01011-546 546/8
	596		MS01011-546 596/8
	646		MS01011-546 646/8
	696	MS01011-546 696/8	
	796	MS01011-546 796/8	
596	596	MS01011-596 596/8	
	646	MS01011-546 646/8	
	696	MS01011-546 696/8	
	796	MS01011-546 796/8	
646	646	MS01011-646 646/8	
	696	MS01011-646 696/8	
	796	MS01011-646 796/8	
246	496	MS01011-246 496/8,5	
296	296	8,5	MS01011-296 296/8,5
	346		MS01011-296 346/8,5
	396		MS01011-296 396/8,5
	446		MS01011-296 446/8,5
	496		MS01011-296 496/8,5

Izolační desky

Insulating plates

MS01011

B	A	h	Katalogové označení
296	546	8,5	MS01011-296 546/8,5
	596		MS01011-296 596/8,5
	696		MS01011-296 696/8,5
346	346		MS01011-346 346/8,5
	396		MS01011-346 396/8,5
	446		MS01011-346 446/8,5
	496		MS01011-346 496/8,5
	546		MS01011-346 546/8,5
	596		MS01011-346 596/8,5
	696		MS01011-346 696/8,5
	796		MS01011-346 796/8,5
396	396		MS01011-396 396/8,5
	446		MS01011-396 446/8,5
	496		MS01011-396 496/8,5
	546		MS01011-396 546/8,5
	596		MS01011-396 596/8,5
	696		MS01011-396 696/8,5
	796		MS01011-396 796/8,5
	896		MS01011-396 896/8,5
446	446		MS01011-446 446/8,5
	496		MS01011-446 496/8,5
	546		MS01011-446 546/8,5
	596		MS01011-446 596/8,5
	696		MS01011-446 696/8,5
	796		MS01011-446 796/8,5
	896		MS01011-446 896/8,5
496	496		MS01011-496 496/8,5
	546		MS01011-496 546/8,5
	596	MS01011-496 596/8,5	
	696	MS01011-496 696/8,5	
	796	MS01011-496 796/8,5	
	896	MS01011-496 896/8,5	
	996	MS01011-496 996/8,5	
546	546	MS01011-546 546/8,5	
	596	MS01011-546 596/8,5	
	646	MS01011-546 646/8,5	
	696	MS01011-546 696/8,5	
	796	MS01011-546 796/8,5	
	896	MS01011-546 896/8,5	
	996	MS01011-546 996/8,5	

Izolační desky
Insulating plates

MS01011

B	A	h	Katalogové označení
596	596	8,5	MS01011-596 596/8,5
	696		MS01011-596 696/8,5
	796		MS01011-596 796/8,5
	896		MS01011-596 896/8,5
	996		MS01011-596 996/8,5
646	596		MS01011-646 596/8,5
	696		MS01011-646 696/8,5
	796		MS01011-646 796/8,5
	896		MS01011-646 896/8,5
	996		MS01011-646 996/8,5
696	696		MS01011-696 696/8,5
	796		MS01011-696 796/8,5
	896		MS01011-696 896/8,5
	996		MS01011-696 996/8,5
796	796		MS01011-796 796/8,5
	896		MS01011-796 896/8,5
	996		MS01011-796 996/8,5
896	896		MS01011-896 896/8,5
	996		MS01011-896 996/8,5

Izolační desky

Insulating plates

MS0102

600 N/mm²

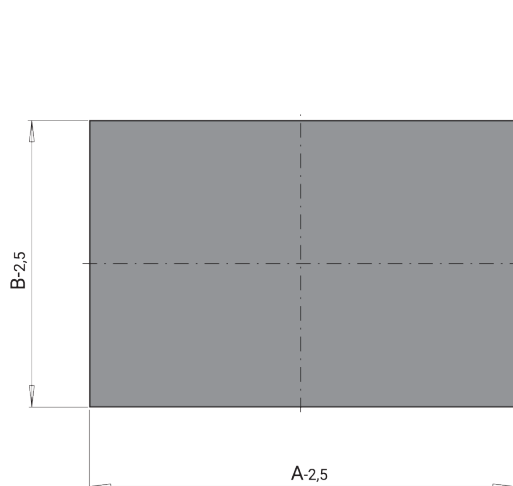

- Maximální provozní teplota:** 340°C
Maximum service temperature
- Kompresní síla:**
Compressive strength:
- 23°C 600 N/mm²
- 200°C 500 N/mm²
- Absorbce vody:** 0,1 %
Water absorption
- Hustota** 1,95 g/cm³
Density
- Teplotní vodivost:** 0,22 W/m K
Thermal conductivity

B	A	h	Katalogové označení
95	95	3	MS0102-095 095/3
100	130		MS0102-100 130/3
156	156		MS0102-156 156/3
	196		MS0102-156 196/3
190	246		MS0102-156 246/3
	196		MS0102-190 246/3
196	196		MS0102-196 196/3
	246		MS0102-196 246/3
206	156		MS0102-206 156/3
	196		MS0102-206 196/3
95	95	5	MS0102-095 095/5
100	130		MS0102-100 130/5
156	156		MS0102-156 156/5
	196		MS0102-156 196/5
	246		MS0102-156 246/5
	296		MS0102-156 296/5
	396		MS0102-156 396/5
190	246		MS0102-190 246/5
	296		MS0102-190 296/5
196	196		MS0102-196 196/5
	246		MS0102-196 246/5
	296		MS0102-196 296/5
	346		MS0102-196 346/5

Izolační desky
Insulating plates

MS0102

B	A	h	Katalogové označení	
206	156	5	MS0102-206 156/5	
	196		MS0102-206 196/5	
218	246		MS0102-218 246/5	
	296		MS0102-218 296/5	
246	246		MS0102-246 246/5	
	296		MS0102-246 296/5	
	346		MS0102-246 346/5	
	396		MS0102-246 396/5	
254	246		MS0102-254 246/5	
276			MS0102-276 246/5	
126	156		6	MS0102-126 156/6
	246			MS0102-126 246/6
156	156			MS0102-156 156/6
	196			MS0102-156 196/6
	206	MS0102-156 206/6		
	246	MS0102-156 246/6		
	296	MS0102-156 296/6		
	346	MS0102-156 346/6		
	396	MS0102-156 396/6		
	446	MS0102-156 446/6		
196	196	MS0102-196 196/6		
	206	MS0102-196 206/6		
	246	MS0102-196 246/6		
	296	MS0102-196 296/6		
	346	MS0102-196 346/6		
	396	MS0102-196 396/6		
	446	MS0102-196 446/6		
	496	MS0102-196 496/6		
216	246	MS0102-216 246/6		
	296	MS0102-216 296/6		
	396	MS0102-216 396/6		
246	246	MS0102-246 246/6		
	266	MS0102-246 266/6		
	296	MS0102-246 296/6		
	346	MS0102-246 346/6		
	396	MS0102-246 396/6		
	446	MS0102-246 446/6		
	496	MS0102-246 496/6		
	546	MS0102-246 546/6		
266	596	MS0102-246 596/6		
	296	MS0102-266 296/6		

Izolační desky

Insulating plates

MS0102

B	A	h	Katalogové označení
196	296	7	MS0102-196 296/7
	346		MS0102-196 346/7
	396		MS0102-196 396/7
	446		MS0102-196 446/7
218	396		MS0102-218 396/7
246	246		MS0102-246 246/7
	296		MS0102-246 296/7
	346		MS0102-246 346/7
	396		MS0102-246 396/7
	446		MS0102-246 446/7
254	246		MS0102-254 246/7
276	296		MS0102-276 296/7
296	296		MS0102-296 296/7
	346		MS0102-296 346/7
	396		MS0102-296 396/7
	446		MS0102-296 446/7
346	346		MS0102-346 346/7
	396		MS0102-346 396/7
	446		MS0102-346 446/7
	496		MS0102-346 496/7
	546	MS0102-346 546/7	
396	396	MS0102-396 396/7	
	446	MS0102-396 446/7	
	496	MS0102-396 496/7	
	546	MS0102-396 546/7	
496	546	MS0102-496 546/7	
296	296	8	MS0102-296 296/8
	346		MS0102-296 346/8
	396		MS0102-296 396/8
	446		MS0102-296 446/8
	496		MS0102-296 496/8
	546		MS0102-296 546/8
	596		MS0102-296 596/8
	646		MS0102-296 646/8
	696		MS0102-296 696/8
346	346		MS0102-346 346/8
	396		MS0102-346 396/8
	446		MS0102-346 446/8
	496		MS0102-346 496/8
	546		MS0102-346 546/8
	596		MS0102-346 596/8
	646		MS0102-346 646/8

Izolační desky
Insulating plates

MS0102

B	A	h	Katalogové označení
346	696	8	MS0102-346 696/8
	796		MS0102-346 796/8
396	396		MS0102-396 396/8
	446		MS0102-396 446/8
	496		MS0102-396 496/8
	546		MS0102-396 546/8
	596		MS0102-396 596/8
	646		MS0102-396 646/8
	696		MS0102-396 696/8
	796		MS0102-396 796/8
446	446		MS0102-446 446/8
	496		MS0102-446 496/8
	546		MS0102-446 546/8
	596		MS0102-446 596/8
	646		MS0102-446 646/8
	696		MS0102-446 696/8
	796		MS0102-446 796/8
496	496		MS0102-496 496/8
	546		MS0102-496 546/8
	596		MS0102-496 596/8
	646		MS0102-496 646/8
	696		MS0102-496 696/8
	796		MS0102-496 796/8
546	546		MS0102-546 546/8
	596	MS0102-546 596/8	
	646	MS0102-546 646/8	
	696	MS0102-546 696/8	
	796	MS0102-546 796/8	
596	596	MS0102-596 596/8	
	646	MS0102-596 646/8	
	696	MS0102-596 696/8	
	796	MS0102-596 796/8	
	896	MS0102-596 896/8	
	996	MS0102-596 996/8	
646	646	MS0102-646 646/8	
	696	MS0102-646 696/8	
	796	MS0102-646 796/8	
	896	MS0102-646 896/8	
	996	MS0102-646 996/8	

Izolační desky

Insulating plates

MS0102

B	A	h	Katalogové označení
696	696	8	MS0102-696 696/8
	746		MS0102-696 746/8
	796		MS0102-696 796/8
	896		MS0102-696 896/8
	996		MS0102-696 996/8
746	796		MS0102-746 796/8
	896		MS0102-746 896/8
	996		MS0102-746 996/8
796	796		MS0102-796 796/8
	846		MS0102-796 846/8
	896		MS0102-796 896/8
	996		MS0102-796 996/8
846	896		MS0102-846 896/8
	996		MS0102-846 996/8
246	496		MS0102-246 496/8,5
296	296	8,5	MS0102-296 296/8,5
	346		MS0102-296 346/8,5
	396		MS0102-296 396/8,5
	446		MS0102-296 446/8,5
	496		MS0102-296 496/8,5
	546		MS0102-296 546/8,5
	596		MS0102-296 596/8,5
	696		MS0102-296 696/8,5
346	346		MS0102-346 346/8,5
	396		MS0102-346 396/8,5
	446		MS0102-346 446/8,5
	496		MS0102-346 496/8,5
	546		MS0102-346 546/8,5
	596		MS0102-346 596/8,5
	696		MS0102-346 696/8,5
	796		MS0102-346 796/8,5
396	396		MS0102-396 396/8,5
	446		MS0102-396 446/8,5
	496		MS0102-396 496/8,5
	546		MS0102-396 546/8,5
	596		MS0102-396 596/8,5
	696		MS0102-396 696/8,5
	796		MS0102-396 796/8,5
	896		MS0102-396 896/8,5

Izolační desky
Insulating plates

MS0102

B	A	h	Katalogové označení
446	446	8,5	MS0102-446 446/8,5
	496		MS0102-446 496/8,5
	546		MS0102-446 546/8,5
	596		MS0102-446 596/8,5
	696		MS0102-446 696/8,5
	796		MS0102-446 796/8,5
	896		MS0102-446 896/8,5
496	496		MS0102-496 496/8,5
	546		MS0102-496 546/8,5
	596		MS0102-496 596/8,5
	696		MS0102-496 696/8,5
	796		MS0102-496 796/8,5
	896		MS0102-496 896/8,5
	996		MS0102-496 996/8,5
546	546		MS0102-546 546/8,5
	596		MS0102-546 596/8,5
	646		MS0102-546 646/8,5
	696		MS0102-546 696/8,5
	796		MS0102-546 796/8,5
	896		MS0102-546 896/8,5
	996		MS0102-546 996/8,5
596	596		MS0102-596 596/8,5
	696		MS0102-596 696/8,5
	796		MS0102-596 796/8,5
	896		MS0102-596 896/8,5
	996		MS0102-596 996/8,5
646	596		MS0102-646 596/8,5
	696		MS0102-646 696/8,5
	796		MS0102-646 796/8,5
	896		MS0102-646 896/8,5
	996		MS0102-646 996/8,5
696	696		MS0102-696 696/8,5
	796		MS0102-696 796/8,5
	896		MS0102-696 896/8,5
	996		MS0102-696 996/8,5
796	796		MS0102-796 796/8,5
	896		MS0102-796 896/8,5
	996		MS0102-796 996/8,5
896	896		MS0102-896 896/8,5
	996		MS0102-896 996/8,5

Izolační desky

Insulating plates

MS01021

600 N/mm²

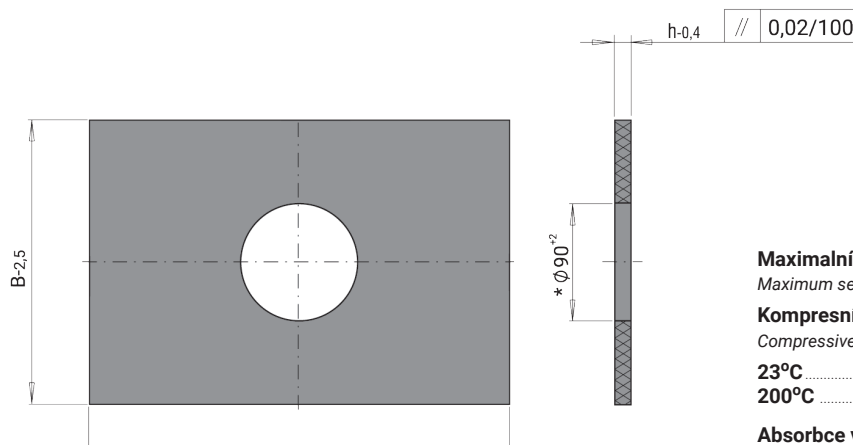

Maximální provozní teplota:	340°C
<i>Maximum service temperature</i>	
Kompresní síla:	
<i>Compressive strength:</i>	
23°C	600 N/mm ²
200°C	500 N/mm ²
Absorbce vody:	0,1 %
<i>Water absorption</i>	
Hustota	1,95 g/cm ³
<i>Density</i>	
Teplotní vodivost:	0,22 W/m K
<i>Thermal conductivity</i>	

* Průměr otvoru 22 mm pro desky 95x95 mm a 100x130 mm
holes diameters 22 mm for plates with sizes 95x95mm and 100x130 mm

B	A	h	Katalogové označení
95*	95*	3	MS01021-095 095/3
100*	130*		MS01021-100 130/3
156	156		MS01021-156 156/3
	196		MS01021-156 196/3
	246		MS01021-156 246/3
190	246		MS01021-190 246/3
196	196		MS01021-196 196/3
	246		MS01021-196 246/3
206	156		MS01021-206 156/3
	196		MS01021-206 196/3
95*	95*	5	MS01021-095 095/5
100*	130*		MS01021-100 130/5
156	156		MS01021-156 156/5
	196		MS01021-156 196/5
	246		MS01021-156 246/5
	296		MS01021-156 296/5
	396		MS01021-156 396/5
190	246		MS01021-190 246/5
	296		MS01021-190 296/5
196	196		MS01021-196 196/5
	246		MS01021-196 246/5
	296		MS01021-196 296/5
	346		MS01021-196 346/5

Izolační desky
Insulating plates

MS01021

B	A	h	Katalogové označení
206	156	5	MS01021-206 156/5
	196		MS01021-206 196/5
218	246		MS01021-218 246/5
	296		MS01021-218 296/5
246	246		MS01021-246 246/5
	296		MS01021-246 296/5
	346		MS01021-246 346/5
	396		MS01021-246 396/5
254	246		MS01021-254 246/5
276			MS01021-276 246/5
126	156	6	MS01021-126 156/6
	246		MS01021-126 246/6
156	156		MS01021-156 156/6
	196		MS01021-156 196/6
	206		MS01021-156 206/6
	246		MS01021-156 246/6
	296		MS01021-156 296/6
	346		MS01021-156 346/6
	396		MS01021-156 396/6
	446		MS01021-156 446/6
196	196		MS01021-196 196/6
	206		MS01021-196 206/6
	246		MS01021-196 246/6
	296		MS01021-196 296/6
	346		MS01021-196 346/6
	396		MS01021-196 396/6
	446		MS01021-196 446/6
216	246		MS01021-216 246/6
	296	MS01021-216 296/6	
	396	MS01021-216 396/6	
246	246	MS01021-246 246/6	
	266	MS01021-246 266/6	
	296	MS01021-246 296/6	
	346	MS01021-246 346/6	
	396	MS01021-246 396/6	
	446	MS01021-246 446/6	
	496	MS01021-246 496/6	
	546	MS01021-246 546/6	
266	596	MS01021-246 596/6	
	296	MS01021-266 296/6	

Izolační desky
Insulating plates

MS01021

B	A	h	Katalogové označení	
196	296	7	MS01021-196 296/7	
	346		MS01021-196 346/7	
	396		MS01021-196 396/7	
	446		MS01021-196 446/7	
218	396		MS01021-218 396/7	
246	246		MS01021-246 246/7	
	296		MS01021-246 296/7	
	346		MS01021-246 346/7	
	396		MS01021-246 396/7	
	446		MS01021-246 446/7	
254	246		MS01021-254 246/7	
276	296		MS01021-276 296/7	
296	296		MS01021-296 296/7	
	346		MS01021-296 346/7	
	396		MS01021-296 396/7	
	446		MS01021-296 446/7	
346	346		MS01021-346 346/7	
	396		MS01021-346 396/7	
	446		MS01021-346 446/7	
	496		MS01021-346 496/7	
	546		MS01021-346 546/7	
396	396		MS01021-396 396/7	
	446		MS01021-396 446/7	
	496		MS01021-396 496/7	
	546		MS01021-396 546/7	
496	546		MS01021-496 546/7	
296	296		8	MS01021-296 296/8
	346			MS01021-296 346/8
	396	MS01021-296 396/8		
	446	MS01021-296 446/8		
	496	MS01021-296 496/8		
	546	MS01021-296 546/8		
	596	MS01021-296 596/8		
	646	MS01021-296 646/8		
	696	MS01021-296 696/8		
	346	346		MS01021-346 346/8
396		MS01021-346 396/8		
446		MS01021-346 446/8		
496		MS01021-346 496/8		
546		MS01021-346 546/8		
596		MS01021-346 596/8		
646		MS01021-346 646/8		

Izolační desky
Insulating plates

MS01021

B	A	h	Katalogové označení
346	696	8	MS01021-346 696/8
	796		MS01021-346 796/8
396	396		MS01021-396 396/8
	446		MS01021-396 446/8
	496		MS01021-396 496/8
	546		MS01021-396 546/8
	596		MS01021-396 596/8
	646		MS01021-396 646/8
	696		MS01021-396 696/8
	796		MS01021-396 796/8
446	446		MS01021-446 446/8
	496		MS01021-446 496/8
	546		MS01021-446 546/8
	596		MS01021-446 596/8
	646		MS01021-446 646/8
	696		MS01021-446 696/8
	796		MS01021-446 796/8
496	496		MS01021-496 496/8
	546		MS01021-496 546/8
	596		MS01021-496 596/8
	646		MS01021-496 646/8
	696		MS01021-496 696/8
	796		MS01021-496 796/8
546	546		MS01021-546 546/8
	596	MS01021-546 596/8	
	646	MS01021-546 646/8	
	696	MS01021-546 696/8	
	796	MS01021-546 796/8	
596	596	MS01021-596 596/8	
	646	MS01021-596 646/8	
	696	MS01021-596 696/8	
	796	MS01021-596 796/8	
646	646	MS01021-646 646/8	
	696	MS01021-646 696/8	
	796	MS01021-646 796/8	
246	496	8,5	MS01021-246 496/8,5
296	296		MS01021-296 296/8,5
	346		MS01021-296 346/8,5
	396		MS01021-296 396/8,5
	446		MS01021-296 446/8,5
	496		MS01021-296 496/8,5
	546		MS01021-296 546/8,5

Izolační desky

Insulating plates

MS01021

B	A	h	Katalogové označení
296	596	8,5	MS01021-296 596/8,5
	696		MS01021-296 696/8,5
346	346		MS01021-346 346/8,5
	396		MS01021-346 396/8,5
	446		MS01021-346 446/8,5
	496		MS01021-346 496/8,5
	546		MS01021-346 546/8,5
	596		MS01021-346 596/8,5
	696		MS01021-346 696/8,5
	796		MS01021-346 796/8,5
396	396		MS01021-396 396/8,5
	446		MS01021-396 446/8,5
	496		MS01021-396 496/8,5
	546		MS01021-396 546/8,5
	596		MS01021-396 596/8,5
	696		MS01021-396 696/8,5
	796		MS01021-396 796/8,5
	896		MS01021-396 896/8,5
446	446		MS01021-446 446/8,5
	496		MS01021-446 496/8,5
	546		MS01021-446 546/8,5
	596		MS01021-446 596/8,5
	696		MS01021-446 696/8,5
	796		MS01021-446 796/8,5
	896		MS01021-446 896/8,5
496	496		MS01021-496 496/8,5
	546		MS01021-496 546/8,5
	596		MS01021-496 596/8,5
	696	MS01021-496 696/8,5	
	796	MS01021-496 796/8,5	
	896	MS01021-496 896/8,5	
	996	MS01021-496 996/8,5	
546	546	MS01021-546 546/8,5	
	596	MS01021-546 596/8,5	
	646	MS01021-546 646/8,5	
	696	MS01021-546 696/8,5	
	796	MS01021-546 796/8,5	
	896	MS01021-546 896/8,5	
	996	MS01021-546 996/8,5	
596	596	MS01021-596 596/8,5	
	696	MS01021-596 696/8,5	
	796	MS01021-596 796/8,5	

Izolační desky
Insulating plates
MS01021

B	A	h	Katalogové označení
596	896	8,5	MS01021-596 896/8,5
	996		MS01021-596 996/8,5
646	596		MS01021-646 596/8,5
	696		MS01021-646 696/8,5
	796		MS01021-646 796/8,5
	896		MS01021-646 896/8,5
	996		MS01021-646 996/8,5
696	696		MS01021-696 696/8,5
	796		MS01021-696 796/8,5
	896		MS01021-696 896/8,5
	996		MS01021-696 996/8,5
796	796		MS01021-796 796/8,5
	896		MS01021-796 896/8,5
	996		MS01021-796 996/8,5
896	896		MS01021-896 896/8,5
	996		MS01021-896 996/8,5

Izolační desky

Insulating plates

MS0103

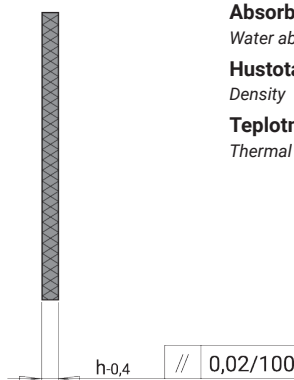
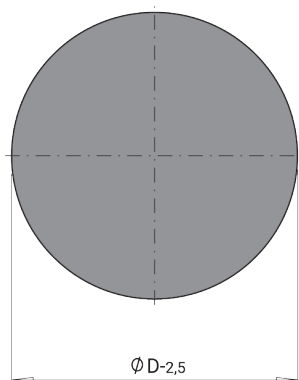

Maximální provozní teplota: 340°C

Maximum service temperature

Kompresní síla:

Compressive strength:

23°C 600 N/mm²

200°C 500 N/mm²

Absorbce vody: 0,1 %

Water absorption

Hustota 1,95 g/cm³

Density

Teplotní vodivost: 0,22 W/m K

Thermal conductivity

D	h	Katalogové označení
95	3	MS0103-095/3
116		MS0103-116/3
156		MS0103-156/3
196	5	MS0103-156/5
246		MS0103-196/5
296		MS0103-246/5
344		MS0103-296/5
	7	MS0103-344/7

Izolační desky

Insulating plates

MS01031

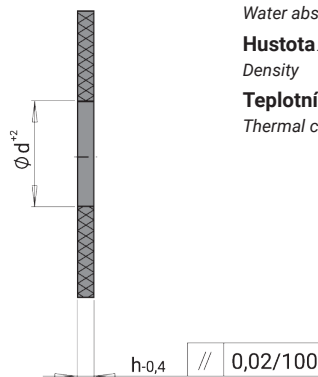
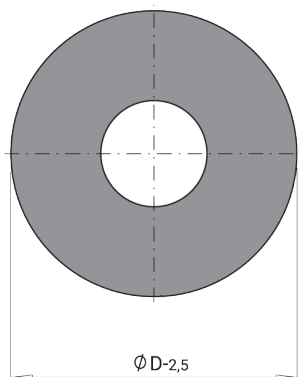

Maximální provozní teplota: 340°C

Maximum service temperature

Kompresní síla:

Compressive strength:

23°C 600 N/mm²

200°C 500 N/mm²

Absorbce vody: 0,1 %

Water absorption

Hustota 1,95 g/cm³

Density

Teplotní vodivost: 0,22 W/m K

Thermal conductivity

D	d	h	Katalogové označení
95	22	3	MS01031-095 22/3
156	90		MS01031-156 90/3
196		5	MS01031-156 90/5
246			MS01031-196 90/5
296			MS01031-246 90/5
344		7	MS01031-296 90/5
			MS01031-344 90/7